

LUFFING JIB DERRICK CRANE

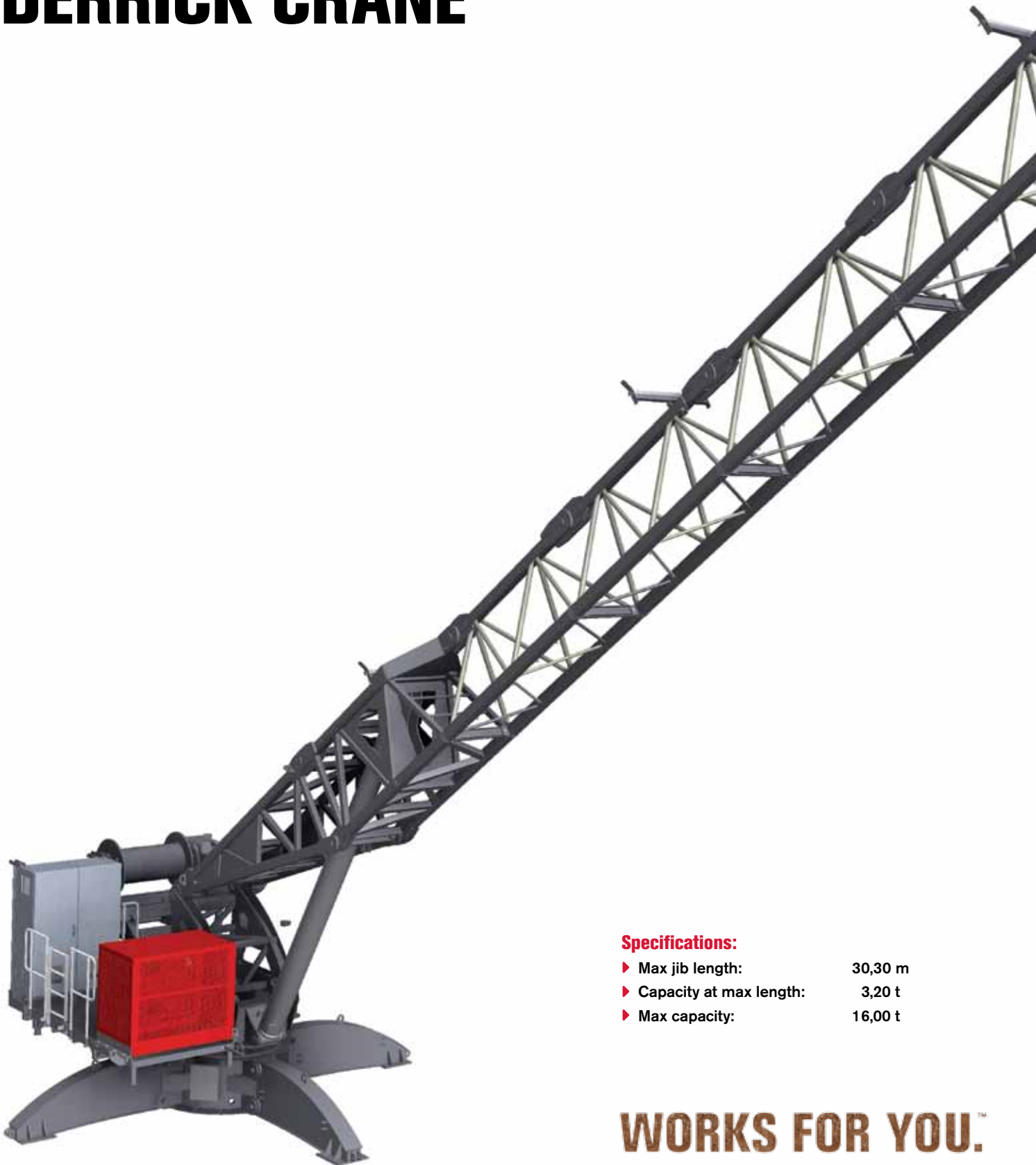

Specifications:

- ▶ Max jib length: 30,30 m
- ▶ Capacity at max length: 3,20 t
- ▶ Max capacity: 16,00 t

WORKS FOR YOU.™

KEY

Zeichenerklärung · Légende · Leyenda · Legenda · Legenda · Условные обозначения

	Hoisting · Heben · Levage · Elevación · Sollevamento · Elevação · Подъем
	Slewing · Schwenken · Orientation · Orientació · Rotazione · Giro · Поворот
	Luffing · Ausleger-Einziehen · Relevage · Elevación de pluma · Brandeggio · Elevação da lança · Изменение вылета стрелы
	Directive on noise level · Richtlinie für den Schall-Leistungspegel · Directive sur le niveau acoustique · Directiva sobre el nivel acustico · Direttiva sul livello acustico · Diretiva sobre nivel de ruidos · Директива по уровню шума
	Consult us · Auf Anfrage · Nous consulter · Consultarnos · Consultateci · Consulte-nos · Проконсультироваться с нами
	Power requirements · Geforderte Stromstärke · Puissance totale nécessaire · Potencia necesaria · Potenza totale richiesta · Requisitos de energia · Требования по питанию
	Power supply · Stromversorgung · Alimentation · Alimentación · Alimentazione · Fonte de alimentação · Питание
	In service · In Betrieb · En service · En servicio · In servizio · Em serviço · При работе
	Out of service · Außer Betrieb · Hors service · Fuera de servicio · Fuori servizio · Fora de serviço · В режиме простоя
	Max. under hook height · Höchste Hakenhöhe · Hauteur maxi. sous crochet · Maxima altura bajo gancho · Altezza max. sotto gancho · Alt. máx. sob o gancho · Макс высота крюка
	Jib · Ausleger · Flèche · Pluma · Braccio · Lança · Стрела
	Without load, without ballast, max. jib and max. height · Ohne Last und Ballast, mit Maximalausleger und Maximalhöhe · A vide, sans lest, avec flèche et hauteur maximum · Sin carga, sin lastre, con pluma y altura máxima · A vuoto, senza zavorra, braccio max., altezza max. · Sem carga, sem lastro, lança máxima, altura máxima · Без груза, без балласта, на макс. Длине вспомогательной стрелы и макс. Высоте

CONTENTS

CDK 100-16

Inhalt · Contenu · Contenido · Indice · Sumário · Содержание

Page · Seite · Page · Página · Pagina · Página · Страница:

Load Diagram · Lastkurven · Courbes de charges · Curvas de cargas · Diagramma di portata · Diagrama de carga · Диаграмма грузоподъёмности	4
Mechanisms · Antriebe · Mécanismes · Mecanismos · Meccanismi · Mecanismo · Механизм	6
Transportation · Transport · Transport · Transporte · Trasporto · Transporte · Транспортировка	7

LOAD DIAGRAM

Lastkurven · Courbes de charges · Curvas de cargas · Diagramma di portata · Diagrama de carga · Диаграмма грузоподъёмности

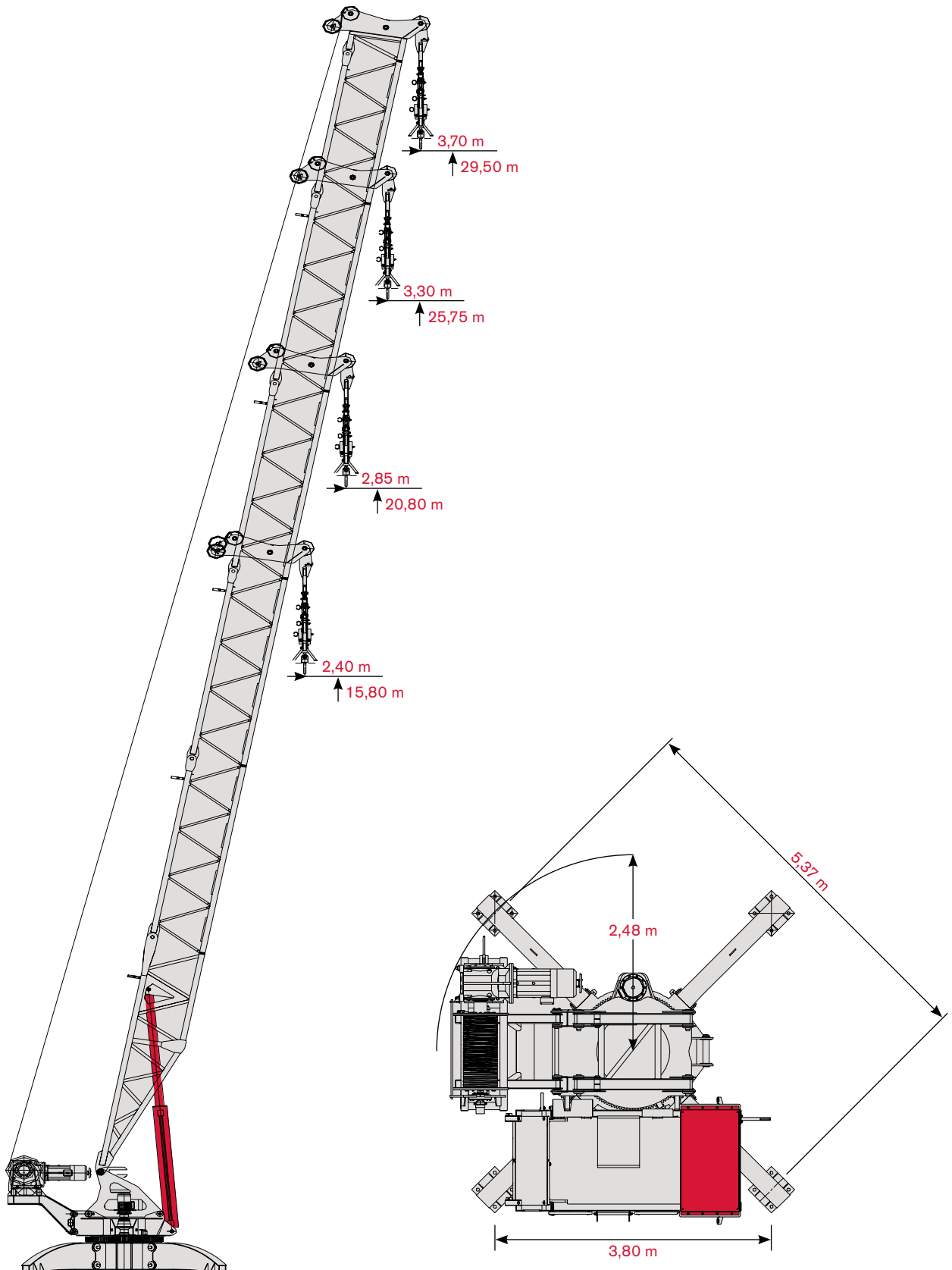

Load Diagram · Lastkurven · Courbes de charges · Curvas de cargas · Diagramma di portata · Diagrama de carga · Схема нагрузок

			6 m	9 m	12 m	15 m	16,5 m	18 m	21,5 m	24 m	26,5 m	30,3 m
 8 t →	16,88 m	t	8,00	8,00	8,00	8,00	8,00	7,33	5,69	4,80	4,08	3,20
 12 t →	12,25 m	t	12,00	12,00	12,00	9,33	8,24	7,33	5,69	4,80	4,08	3,20
 16 t →	9,56 m	t	16,00	16,00	12,29	9,33	8,24	7,33	5,69	4,80	4,08	3,20
 8 t →	16,67 m	t	8,00	8,00	8,00	8,00	8,00	7,21	5,60	4,73	4,00	
 12 t →	12,07 m	t	12,00	12,00	12,00	9,18	8,11	7,21	5,60	4,73	4,00	
 16 t →	9,42 m	t	16,00	16,00	12,08	9,18	8,11	7,21	5,60	4,73	4,00	
 8 t →	16,27 m	t	8,00	8,00	8,00	8,00	7,85	6,99	5,40			
 12 t →	11,74 m	t	12,00	12,00	11,69	8,88	7,85	6,99	5,40			
 16 t →	9,14 m	t	16,00	16,00	11,69	8,88	7,85	6,99	5,40			
 8 t →	15,78 m	t	8,00	8,00	8,00	8,00	7,50					
 12 t →	11,33 m	t	12,00	12,00	11,21	8,53	7,50					
 16 t →	8,79 m	t	16,00	15,58	11,21	8,53	7,50					

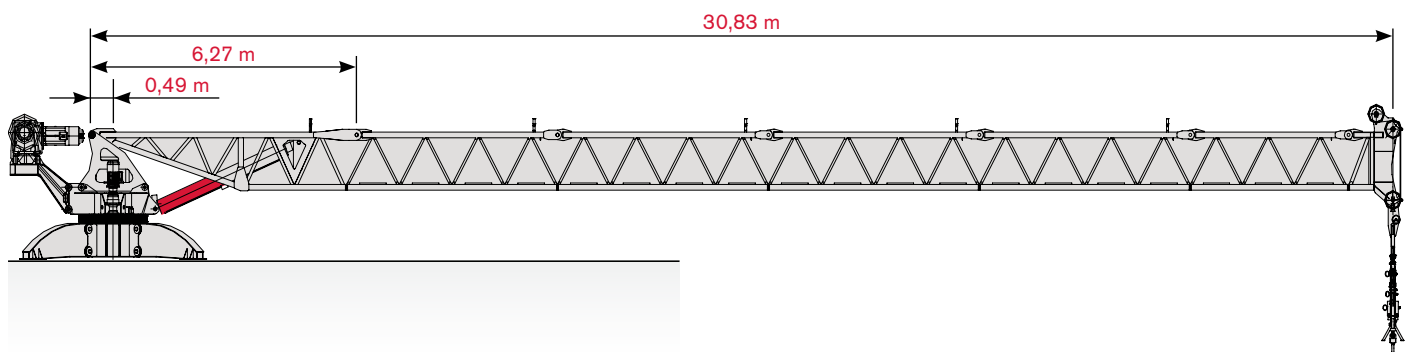
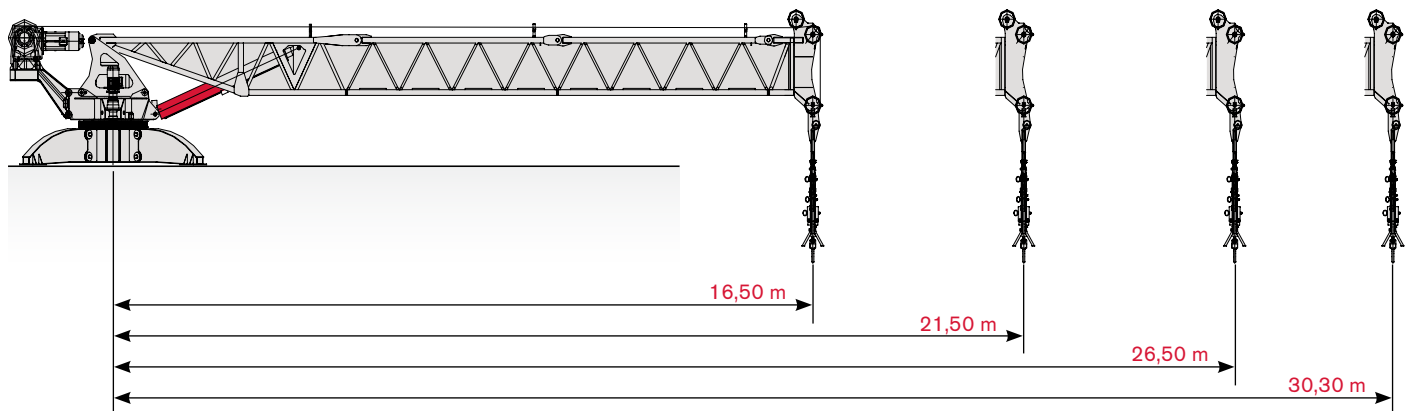

Jib Configurations · Auslegerkonfigurationen · Configurations de la flèche · Configuraciones de pluma · Configurazioni braccio · Configurações da Lança · Конфигурация стрелы



MECHANISMS







Antriebe · Mécanismes · Mecanismos · Meccanismi · Mecanismo · Механизм

Power supply · Stromversorgung · Alimentation · Suministro eléctrico · Alimentazione · Requisitos de energia · Требования по питанию

				
	35 AFC 80	87 kVA*	400V - 50Hz / 460V - 60 Hz	2000/14/CE modificata

* Average consumption · Durchschnittsverbrauch · Consommation moyenne · Consumo medio · Consumo medio · Consumo médio · Среднее потребление

Hoisting · Heben · Levage · Elevación · Sollevamento · Elevação · Подъем

			t	m/min	kW	
	35 AFC 80		8	0 → 23	37	850 m
			6	0 → 28		
			2	0 → 59		
			12	0 → 14		
			9	0 → 18		
			3	0 → 39		
			16	0 → 12		
			12	0 → 14		

Additional Specifications · Weitere Leistungsdaten · Spécifications additionnelles · Otras prestaciones · Altre movimentazioni · Especificações adicionais · Дополнительные спецификации









			
	LHY 140	2,5 min	30 kW
	SFC 1-65	0 → 0,75 r.p.m.	1 x 10 kW

TRANSPORTATION

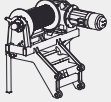
CDK 100-16

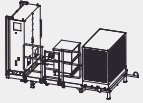
Transport · Transport · Transporte · Trasporto · Transporte · Транспортировка

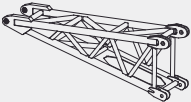
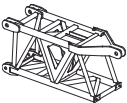
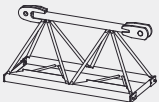
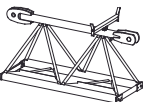
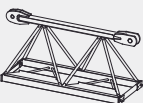

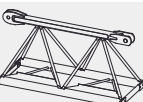

Packing list

CDK100-16	DESCRIPTION · BESCHREIBUNG · DESCRIPTION · DESCRIPCIÓN · DESCRIZIONE · DESCRIÇÃO · ОПИСАНИЕ	LENGTH · LÄNGE · LONGUEUR · LONGITUD · LUNGHEZZA · COMPRIMENTO · ДЛИНА	WIDTH · BREITE · LARGEUR · ANCHURA · LARGHEZZA · LARGURA · ШИРИНА	HEIGHT · HÖHE · HAUTEUR · ALTURA · ALTEZZA · ALTURA · ВЫСОТА	QUANTITY · MENGE · QUANTITÉ · CANTIDAD · QUANTITÀ · QUANTIDADE · КОЛИЧЕСТВО	WEIGHT · GEWICHT · POIDS · PESO · PESO · ВЕС
	BASE SUPPORT	2,07 m	0,45 m	0,77 m	4	385 kg
	SLEWING UNIT	2,23 m	2,16 m	2,00 m	1	3352 kg
	COUNTER JIB UNIT	1,82 m	2,41 m	2,08 m	1	2584 kg
	JIB CONNECTION FRAME	1,66 m	1,06 m	1,27 m	1	623,7 kg
	PLATFORM	3,23 m	1,81 m	2,06 m	1	2060 kg
	LUFFING RAMS	3,88 m	0,42 m	0,44 m	1	1370 kg
	JIB SECTION 01	3,89 m	1,06 m	1,30 m	1	1135 kg
	JIB SECTION 02	3,00 m	1,08 m	1,32 m	1	1233 kg
	JIB SECTION 03	2,64 m	1,02 m	1,27 m	1	425 kg
	JIB SECTION 04	2,77 m	1,02 m	1,29 m	1	403,5 kg
	JIB SECTION 05	2,76 m	1,02 m	1,29 m	1	398 kg
	JIB SECTION 06	2,74 m	1,02 m	1,28 m	1	339,5 kg
	JIB SECTION 07	2,71 m	1,02 m	1,28 m	1	303 kg

WORKS FOR YOU.™

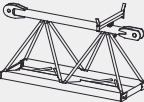
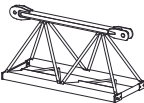
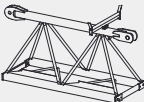
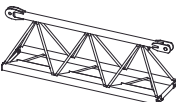
TRANSPORTATION

Transport · Transport · Transporte · Trasporto · Transporte · Транспортировка

CDK100-16	DESCRIPTION · BESCHREIBUNG · DESCRIPTION · DESCRIPCIÓN · DESCRIZIONE · DESCRIÇÃO · ОПИСАНИЕ	LENGTH · LÄNGE · LONGUEUR · LONGITUD · LUNGHEZZA · COMPRIMENTO · ДЛИНА	WIDTH · BREITE · LARGEUR · ANCHURA · LARGHEZZA · LARGURA · ШИРИНА	HEIGHT · HÖHE · HAUTEUR · ALTURA · ALTEZZA · ALTURA · ВЫСОТА	QUANTITY · MENGE · QUANTITÉ · CANTIDAD · QUANTITÀ · QUANTIDADE · КОЛИЧЕСТВО	WEIGHT · GEWICHT · POIDS · PESO · PESO · ВЕС
	JIB SECTION 08	2,71 m	1,02 m	1,28 m	1	299,5 kg
	JIB SECTION 09	2,71 m	1,02 m	1,28 m	1	244 kg
	JIB SECTION 10	2,82 m	1,02 m	1,28 m	1	244,5 kg
	JIB SECTION 11	3,97 m	1,02 m	1,28 m	1	320,5 kg
	JIB END	1,40 m	1,02 m	2,26 m	1	524 kg
	SWINGING SUPPORT	1,20 m	0,32 m	1,55 m	1	164 kg
	HOIST BLOCK UNIT	1,20 m	0,12 m	1,46 m	1	537,4 kg

NOTES

CDK 100-16

Notizen · Note · Apunte · Appunti · Notas · Заметки

NOTES

Notizen · Note · Apunte · Appunti · Notas · Заметки

Effective Date: June 2015.

Product specifications and prices are subject to change without notice or obligation. The photographs and/or drawings in this document are for illustrative purposes only. Refer to the appropriate Operator's Manual for instructions on the proper use of this equipment. Failure to follow the appropriate Operator's Manual when using our equipment or to otherwise act irresponsibly may result in serious injury or death. The only warranty applicable to our equipment is the standard written warranty applicable to the particular product and sale and Terex makes no other warranty, express or implied. Products and services listed may be trademarks, service marks or trade-names of Terex Corporation and/or its subsidiaries in the USA and other countries. All rights are reserved. Terex® is a registered trademark of Terex Corporation in the USA and many other countries.

Gültig ab: Juni 2015.

Produktbeschreibungen und Preise können jederzeit und ohne Verpflichtung zur Ankündigung geändert werden. Die in diesem Dokument enthaltenen Fotos und/oder Zeichnungen dienen rein anschaulichen Zwecken. Anweisungen zur ordnungsgemäßen Verwendung dieser Ausrüstung entnehmen Sie bitte dem zugehörigen Betriebshandbuch. Nichtbefolgung des Betriebshandbuchs bei der Verwendung unserer Produkte oder anderweitig fahrlässiges Verhalten kann zu schwerwiegenden Verletzungen oder Tod führen. Für dieses Produkt wird ausschließlich die entsprechende, schriftlich niedergelegte Standardgarantie gewährt. Terex leistet keinerlei darüber hinaus gehende Garantie, weder ausdrücklich noch stillschweigend. Die Bezeichnungen der aufgeführten Produkte und Leistungen sind gegebenenfalls Marken, Servicemarken oder Handelsnamen der Terex Corporation und/oder ihrer Tochtergesellschaften in den USA und anderen Ländern. Alle Rechte vorbehalten. „TEREX“ ist eine eingetragene Marke der Terex Corporation in den USA und vielen anderen Ländern.

Date d'effet : Juin 2015.

Les spécifications et prix des produits sont sujets à modification sans avis ou obligation. Les photographies et/ou dessins contenus dans ce documents sont uniquement pour illustration. Veuillez vous référer à la notice d'utilisation appropriée pour les instructions quant à l'utilisation correcte de cet équipement. Tout manquement au suivi de la notice d'utilisation appropriée lors de l'utilisation de notre équipement ou tout acte autrement irresponsable peut résulter en blessure corporelle sérieuse ou mortelle. La seule garantie applicable à notre équipement est la garantie standard écrite applicable à un produit et à une vente spécifique. Terex n'offre aucune autre garantie, expresse ou implicite. Les produits et services proposés peuvent être des marques de fabrique, des marques de service ou des appellations commerciales de Terex Corporation et/ou ses filiales aux Etats Unis et dans les autres pays, et tous les droits sont réservés. «TEREX» est une marque déposée de Terex Corporation aux Etats Unis et dans de nombreux autres pays.

Fecha efectiva: Junio 2015.

Los precios y las especificaciones de productos pueden sufrir cambios sin aviso previo u obligación. Las fotografías o dibujos de este documento tienen un fin meramente ilustrativo. Consulte el manual de instrucciones del operador correspondiente para más información sobre el uso correcto de este equipo. El hecho de no respetar el manual del operador correspondiente al utilizar el equipo o actuar de forma irresponsable puede suponer lesiones graves o fatales. La única garantía aplicable a nuestro equipo es la garantía escrita estándar correspondiente a cada producto y venta, y TEREX no amplía dicha garantía de forma expresa o implícita. Los productos y servicios mencionados pueden ser marcas registradas, marcas de servicio o nombres de marca de TEREX Corporation o de sus filiales en Estados Unidos de América y otros países, y se reservan todos los derechos. „TEREX“ es una marca comercial registrada de Terex Corporation en Estados Unidos de América y muchos otros países.

Data di inizio validità: Giugno 2015.

Ci riserviamo il diritto di modificare le specifiche e i prezzi dei prodotti in ogni momento e senza preavviso. Le fotografie e/o i disegni contenuti in questo documento sono destinati unicamente a scopi illustrativi. Consultare le istruzioni sull'uso corretto di questo macchinario, contenute nell'opportuno Manuale dell'operatore. L'inottemperanza delle istruzioni contenute nel Manuale dell'operatore del macchinario e altri comportamenti irresponsabili possono provocare gravi lesioni, anche mortali. L'unica garanzia applicabile ai nostri macchinari è la garanzia scritta standard applicabile al particolare prodotto e alla particolare vendita; Terex è esonerata dal fornire qualsiasi altra garanzia, esplicita o implicita. I prodotti e servizi elencati possono essere dei marchi di fabbrica, marchi di servizio o nomi commerciali di TEREX Corporation e/o società affiliate negli Stati Uniti d'America e altre nazioni e tutti i diritti sono riservati. „TEREX“ è un marchio registrato di Terex Corporation negli USA e molti altri Paesi.

Data de vigência: Junho 2015.

Especificações e preços dos produtos sujeitos a alteração sem aviso prévio ou obrigações. As fotografias e/ou desenhos deste documento servem apenas para fins ilustrativos. Consulte o respectivo Manual de Instruções para instruções sobre o uso correto deste equipamento. A falta de atenção ao respectivo Manual do Operador no uso de nosso equipamento ou a operação da máquina em condições impróprias pode resultar em lesão grave ou morte. A única garantia aplicável aos nossos equipamentos é a garantia padrão por escrito, aplicável ao produto específico e à sua venda, sem que nenhuma outra, expressa ou implícita, seja oferecida pela Terex. Os produtos e serviços listados podem ser marcas comerciais, marcas de serviço ou nomes-fantasia da Terex Corporation e/ou suas subsidiárias nos EUA e em outros países. Todos os direitos reservados. Terex® é marca registrada da Terex Corporation nos EUA e muitos outros países.

Вступает в силу: Июнь 2015.

Технические характеристики и цены могут изменяться без предварительного уведомления и без каких-либо обязательств для производителя. Фотографии и (или) чертежи, использованные в документе, приведены исключительно в качестве иллюстраций. Инструкции по правилам эксплуатации даются в соответствующих руководствах для операторов данного оборудования. Невыполнение рекомендаций руководства по эксплуатации нашего оборудования или другие безответственные действия могут повлечь серьезные травмы или смерть. Единственной гарантией, действующей в отношении нашего оборудования, является стандартная форма письменной гарантии на данный тип оборудования и на условия его продажи.



Copyright 2015 Terex Corporation

Terex Cranes, Global Marketing, Dinglerstraße 24, 66482 Zweibrücken, Germany
Tel. +49 (0) 6332 830, Email: info.cranes@terex.com, www.terexcranes.com

Brochure Reference: TC-DS-M-E/F/G//S/P/R-CDK100-16-06/15

www.terexcranes.com



WORKS FOR YOU.™