

15/18/20D-9S

Diesel Counterbalance Trucks

MOVING YOU FURTHER

HYUNDAI HEAVY INDUSTRIES



■ Photo may include optional equipment



Your satisfaction is **our priority!**

Hyundai introduces a new line of 9-series diesel forklift trucks. The newly designed 4 wheel counterbalance trucks provide every operator comfortable driving, increased productivity and easy maintenance.



New Diesel Forklift with Proven Quality and Advanced Technology

- **Maximum performance**
- **Spacious operator's room**
- **Switch type parking brake**
- **5.6 inch LCD color monitor**
- **Truck inclination warning system**
- **Easy serviceability**
- **Password starting system**
- **OPS System for safe operation (Optional)**
- **Auto fork leveling system (Optional)**
- **Load weight indicator (Optional)**



■ Photo may include optional equipment

High Efficiency & **Optimal Performance**



■ Photo may include optional equipment



KUBOTA V2203 Engine **30.8kW / 2,400 rpm**

High Power Engine - KUBOTA V2203

The Kubota V2203 engine ensures an incomparable performance and durability; with its market approved quality, this engine gives an additional value to the machine. With its power of 30.8kW, it will fit for any work, even with special attachments that require extensive power.

Powerful engine and high technology systems provide you with enhanced performance and highest productivity.

15/18/20D-9S



Clutch Protection System

The clutch protection system prevents excessive use of inching as well as minimizes change-impact.



Highly durable drive axle

The strengthened drive axle separable from transmission ensures low vibration and easy maintenance. The wet disc type brake is applied maintenance free.



Max. Travel Speed

Model	Km / h
15D-9A	18.3
18D-9A	18.3
20D-9A	18.3

Max. Gradeability

Model	%
15D-9A	42.3
18D-9A	37.8
20D-9A	35.1

Faster Travel Speed and Gradeability

The powerful high-output engine provides greater acceleration, better gradeability and faster travel speed on any tough terrain or slope.

Ergonomic & Productivity features



Spacious Operator Cabin

The newly designed cabin provides wide visibility and spacious environment, ensuring all day comfort for the operator.

■ Photo may include optional equipment



Optimized pedal position

On the 9-series the pedals are mounted to the console to reduce operator fatigue, noise and dust entering the engine compartment.

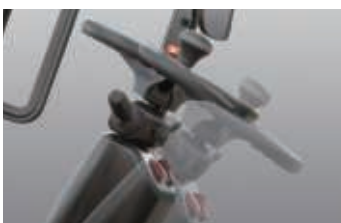

Adjustable steering Wheel

To achieve a comfortable drive position, the angle of the steering column can easily be adjusted.



Comfortable Grammer Seat

Easily adjustable suspension seat, based on a human engineering design, reduces operator fatigue and provides greater comfort.

*ELR (Energy Locking Retractor) Type Seat Belt

*Heating and Head-rest (OPT)

*Movable Armrests

The ergonomically designed cabin and the new style LCD color monitor provides full support and comfort to the operator.

15/18/20D-9S

Advanced LCD Monitor

The 5.6 inch wide screen LCD color monitor allows the operator to control the machine with ease. The monitor features speed, travel direction, battery discharge indicator and hour meter.

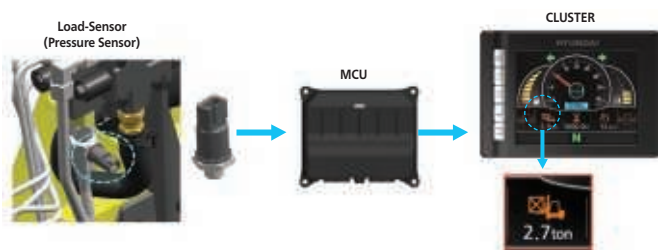

Load indicator (Option)

The optional load indicator displays the load weight in the monitor. The load sensor reduces the time to check loaded weight and the alarm alerts the driver when overloaded.



Auto Fork Leveling System (Optional)

At the touch of a button the mast stops tilting when in upright position.

Advanced **Safety**



Excellent visibility for safe operation

Optimized lift cylinder arrangement provides operator with wider visibility. The panoramic mirror expands the driver's view when backing up.

■ Photo may include optional equipment



Improved Overhead Guard

The strength and all round visibility of the overhead guard further improve safety of the truck



Steel Side Cover (Optional)

The strengthened steel side cover provides enhanced durability.



Low entrance height

The low entrance height ensures easy and safe access for the operator.

The safely designed driver's space makes your operating more comfortable.

15/18/20D-9S

Fork safety features

When the forks are being lowered, a down-control valve maintains the controlled speed. The down-safety valve prevents forks from dropping down in case of sudden damage of hydraulic line.

OPSS (Operator Presence Sensing System)

All mast and drive movements stop functioning when the operator is not in the seat.



■ Photo may include optional equipment



Safety lamps & rear reflectors

Halogen headlights and rear LED combination lights offer the driver visibility in all circumstances. Rear reflectors mounted on the counterweight enhance safety for the driver and the application.

Fast and Easy Maintenance

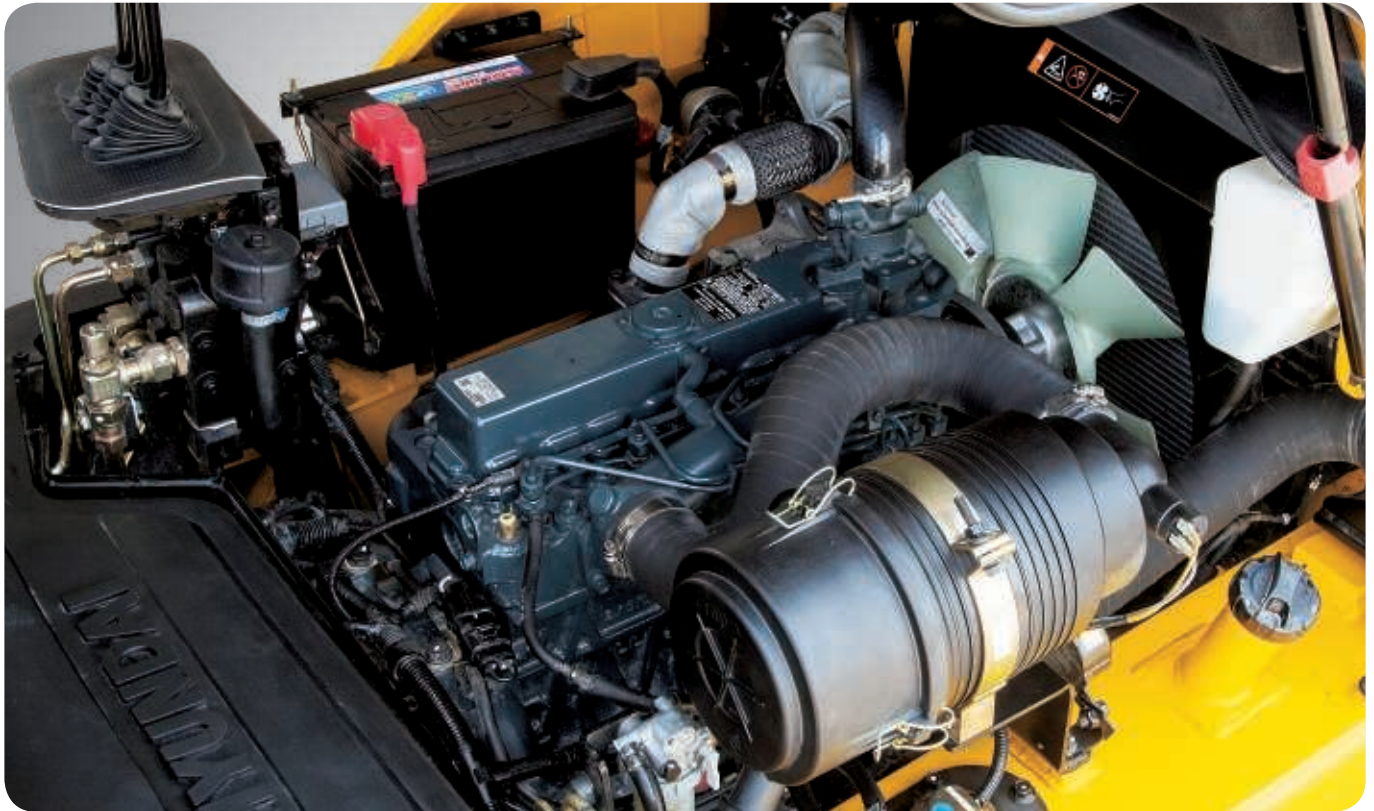

Large Engine Hood

Highly accessible engine compartment assures fast and efficient maintenance.

■ Photo may include optional equipment



Waterproof & Dustproof cover

Newly developed Waterproof and Dustproof fuse box and relay box for ease of maintenance.



Air cleaner

The air cleaner (6") is readily accessible for cleaning or replacement.

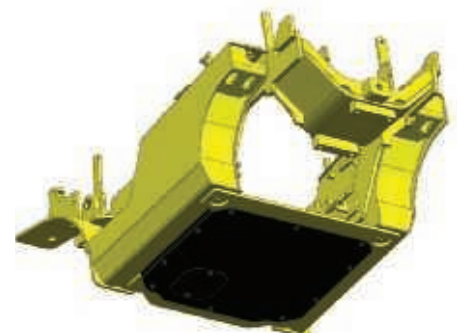

Under Cover (Optional)

The Under cover protect the engine and components from dusts caused by ground. It helps to lengthen Components life.

An ideal arrangement of components ensures easy access and convenience for maintenance.

15/18/20D-9S



Parking Brake Switch

With auto parking function when the operator is not in the seat

Emergency switch (Optional)

■ Photo may include optional equipment



Stylish and convenient switch

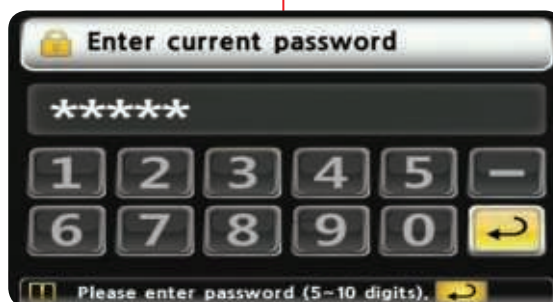

Password starting system (Anti-theft system)

New 9 Series

Mast Specification (15D-9S)

Mast Type		Maximum Fork Height		Overall Height (Lowered)		Free Lift Height				Tilt Angle	Load Capacity without side shift		Load Capacity with side shift		Truck Weight (Unloaded)	
						With Load Backrest		Without Load Backrest			500mm LC		500mm LC			
		in	mm	in	mm	in	mm	in	mm		deg	lb	kg	lb	kg	lb
2-Stage Limited free lift	V250	99.4	2525	69.1	1755	1.4	35	1.4	35	6/10	3000	1500	2900	1425	6235	2834
	V270	107.3	2725	73.0	1855					6/10	3000	1500	2900	1425	6263	2847
	V300	119.1	3025	78.9	2005					6/10	3000	1500	2900	1425	6307	2867
	V330	130.9	3325	84.8	2155					6/10	3000	1500	2900	1425	6349	2886
	V350	138.8	3525	88.8	2255					6/10	3000	1500	2900	1425	6380	2900
	V370	146.7	3725	92.7	2355					6/10	3000	1500	290	1425	6409	2913
	V400	158.5	4025	98.6	2505					6/10	3000	1500	2900	1425	6461	2937
	V450	178.1	4525	112.4	2855					6/6	2900	1425	2770	1350	6633	3015
	V500	197.8	5025	122.2	3105					6/6	2750	1350	2640	1275	6710	3050
V550	217.5	5525	132.1	3355	6/5	2150	1050	2040	1000	6776	3080					
2-Stage full free lift	VF/VS300	119.1	3025	78.9	2005	39.6	1007	60.6	1539	6/6	3000	1500	2900	1425	6409	2913
	VF/VS330	130.9	3325	84.8	2155	45.6	1157	66.5	1689	6/6	3000	1500	2900	1425	6483	2947
	VF/VS350	138.8	3525	88.8	2255	49.5	1257	70.4	1789	6/6	3000	1500	2900	1425	6514	2961
3-Stage full free lift	TF/TS370	147.0	3735	71.1	1805	31.8	807	51.0	1295	6/6	3000	1500	2900	1425	6547	2976
	TF/TS400	158.9	4035	75.0	1905	35.7	907	54.9	1395	6/6	2990	1475	2880	1400	6589	2995
	TF/TS430	170.7	4335	78.9	2005	39.6	1007	58.9	1495	6/6	2900	1425	2790	1350	6631	3014
	TF/TS450	178.5	4535	82.9	2105	43.6	1107	66.7	1695	6/6	2830	1400	2720	1325	6677	3035
	TF/TS470	186.4	4735	84.8	2155	45.6	1157	64.8	1645	6/6	2790	1375	2600	1300	6701	3046
	TF/TS500	198.2	5035	88.8	2255	49.5	1257	68.7	1745	6/6	2750	1350	2610	1275	6741	3064
	TF/TS550	217.9	5535	96.7	2455	57.4	1457	76.6	1945	6/5	2310	1125	2220	1075	6831	3105
	TF/TS600	237.6	6035	104.5	2655	65.2	1657	84.4	2145	6/5	1650	800	1580	750	6930	3150
	TF/TS650	257.3	6535	112.4	2855	73.1	1857	92.3	2345	3/3	1250	600	1180	550	7031	3196
	TF/TS700	277.0	7035	120.3	3055	81.0	2057	100.2	2545	3/3	830	400	770	350	7135	3243

Mast Specification (18D-9S)

Mast Type		Maximum Fork Height		Overall Height (Lowered)		Free Lift Height				Tilt Angle	Load Capacity without side shift		Load Capacity with side shift		Truck Weight (Unloaded)	
						With Load Backrest		Without Load Backrest			500mm LC		500mm LC			
		in	mm	in	mm	in	mm	in	mm		deg	lb	kg	lb	kg	lb
2-Stage Limited free lift	V250	99.4	2525	69.1	1755	1.4	35	1.4	35	6/10	3500	1800	3390	1675	6596	2998
	V270	107.3	2725	73.0	1855					6/10	3500	1800	3390	1675	6622	3010
	V300	119.1	3025	78.9	2005					6/10	3500	1800	3390	1675	6666	3030
	V330	130.9	3325	84.8	2155					6/10	3500	1800	3390	1675	6710	3050
	V350	138.8	3525	88.8	2255					6/10	3500	1770	3390	1675	6739	3063
	V370	146.7	3725	92.7	2355					6/10	3500	1750	3390	1675	6767	3076
	V400	158.5	4025	98.6	2505					6/10	3450	1700	3320	1625	6820	3100
	V450	178.1	4525	112.4	2855					6/6	3300	1625	3170	1550	6992	3178
	V500	197.8	5025	122.2	3105					6/6	2860	1400	2750	1325	7069	3213
V550	217.5	5525	132.1	3355	6/5	2060	1050	1960	1000	7137	3244					
2-Stage full free lift	VF/VS300	119.1	3025	78.9	2005	39.6	1007	60.6	1539	6/6	3500	1800	3390	1675	6767	3076
	VF/VS330	130.9	3325	84.8	2155	45.6	1157	66.5	1689	6/6	3500	1750	3390	1675	6842	3110
	VF/VS350	138.8	3525	88.8	2255	49.5	1257	70.4	1789	6/6	3500	1750	3390	1675	6873	3124
3-Stage full free lift	TF/TS370	147.0	3735	71.1	1805	31.8	807	51.0	1295	6/6	3500	1725	3370	1650	6906	3139
	TF/TS400	158.9	4035	75.0	1905	35.7	907	54.9	1395	6/6	3410	1675	3280	1600	6948	3158
	TF/TS430	170.7	4335	78.9	2005	39.6	1007	58.9	1495	6/6	3320	1625	3190	1500	6989	3177
	TF/TS450	178.5	4535	82.9	2105	43.6	1107	66.7	1695	6/6	3260	1600	3120	1525	7038	3199
	TF/TS470	186.4	4735	84.8	2155	45.6	1157	64.8	1645	6/6	3060	1500	2950	1425	7060	3209
	TF/TS500	198.2	5035	88.8	2255	49.5	1257	68.7	1745	6/6	2970	1450	2860	1375	7099	3227
	TF/TS550	217.9	5535	96.7	2455	57.4	1457	76.6	1945	6/5	2380	1150	2310	1100	7190	3268
	TF/TS600	237.6	6035	104.5	2655	65.2	1657	84.4	2145	6/5	1650	800	1580	750	7289	3313
	TF/TS650	257.3	6535	112.4	2855	73.1	1857	92.3	2345	3/3	1250	600	1190	550	7390	3359
	TF/TS700	277.0	7035	120.3	3055	81.0	2057	100.2	2545	3/3	950	450	880	400	7493	3406

Mast Specification (20D-9S)

Mast Type		Maximum Fork Height		Overall Height (Lowered)		Free Lift Height				Tilt Angle	Load Capacity without side shift		Load Capacity with side shift		Truck Weight (Unloaded)	
						With Load Backrest		Without Load Backrest			500mm LC		500mm LC			
		in	mm	in	mm	in	mm	in	mm		deg	lb	kg	lb	kg	lb
2- Stage Limited free lift	V250	99.6	2530	69.1	1755	1.6	40	1.6	40	6/10	4000	2000	3870	1900	6965	3166
	V270	107.5	2730	73.0	1855					6/10	4000	2000	3870	1900	6994	3179
	V300	119.3	3030	78.9	2005					6/10	4000	2000	3870	1900	7038	3199
	V330	131.1	3330	84.8	2155					6/10	4000	2000	3870	1900	7080	3218
	V350	139.0	3530	88.8	2255					6/10	4000	2000	3870	1900	7110	3232
	V370	146.9	3730	92.7	2355					6/10	3960	1950	3810	1875	7139	3245
	V400	158.7	4030	98.6	2505					6/10	3370	1650	3230	1575	7192	3269
	V450	178.3	4530	112.4	2855					6/6	3320	1625	3190	1550	7363	3347
	V500	198.0	5030	122.2	3105					6/6	2880	1400	2750	1325	7440	3382
	V550	217.7	5530	132.1	3355					6/5	2180	1050	2090	1000	7509	3413
2- Stage full free lift	VF/VS300	119.3	3030	78.9	2005	39.8	1012	60.8	1544	6/6	4000	2000	3870	1900	7139	3245
	VF/VS330	131.1	3330	84.8	2155	45.7	1162	66.7	1694	6/6	4000	1975	3830	1875	7214	3279
	VF/VS350	139.0	3530	88.8	2255	49.7	1262	70.6	1794	6/6	3960	1950	3780	1850	7245	3293
3- Stage full free lift	TF/TS370	147.2	3740	71.1	1805	32.0	812	51.2	1300	6/6	3850	1900	3720	1825	7278	3308
	TF/TS400	159.1	4040	75.0	1905	35.9	912	55.1	1400	6/6	3760	1850	3630	1775	7319	3327
	TF/TS430	170.9	4340	78.9	2005	39.8	1012	59.1	1500	6/6	3670	1800	3540	1725	7361	3346
	TF/TS450	178.7	4540	82.9	2105	43.8	1112	63.0	1600	6/6	3590	1750	3450	1675	7407	3367
	TF/TS470	186.6	4740	84.8	2155	45.7	1162	65.0	1650	6/6	3370	1650	3260	1575	7432	3378
	TF/TS500	198.4	5040	88.8	2255	49.7	1262	68.9	1750	6/6	2990	1450	2880	1400	7471	3396
	TF/TS550	218.1	5540	96.7	2455	57.6	1462	76.8	1950	6/5	2380	1150	2290	1100	7561	3437
	TF/TS600	237.8	6040	104.5	2655	65.4	1662	84.6	2150	6/5	1670	800	1580	750	7660	3482
	TF/TS650	257.5	6540	112.4	2855	73.3	1862	92.5	2350	3/3	1300	625	1230	575	7762	3528
	TF/TS700	277.2	7040	120.3	3055	81.2	2062	100.4	2550	3/3	950	450	880	400	7865	3575

Optional Items

- **Fork (mm)**

15 / 18D-9S : 750; 850; 900 (STD); 1050; 1200; 1350; 1500
 20D-9S : 900 (STD); 950; 1000; 1050; 1150; 1200; 1350; 1500; 1600

- **Overshoe (mm)**

1300; 1500; 1700

- **Sideshift, Integral Sideshift**

- **Tire** : Pneumatic (STD) / Solid / Non-marking

- **M.C.V** : 2-Spool, 3-Spool (STD), 4-Spool

- **Under cover**

- **Load Indicator**

- **Rear Work Lamp (LED)**

- **Beacon Lamp LED (Blue, Red, Amber)**

- **Auto Fork Leveling System**

- **Seat** : Armrest, Heat, Backrest Ext, Buckle SW

- **Hydraulic Pump Temperature / Pressure on Monitor**

- **Battery Disconnect Switch (Master Switch)**

- **OPSS (Travel, Mast)**

- **Emergency Switch**

- **Fire Extinguisher**

- **Pre Cleaner**

*The options in this brochure are subject to change improve to performance of the forklift.

New 9 Series

Dimensions

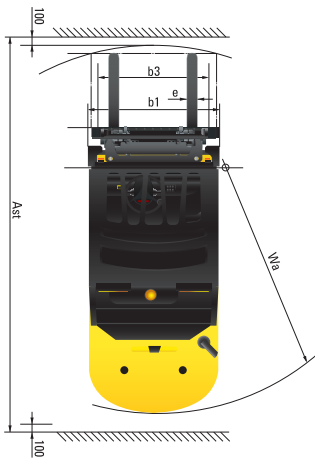
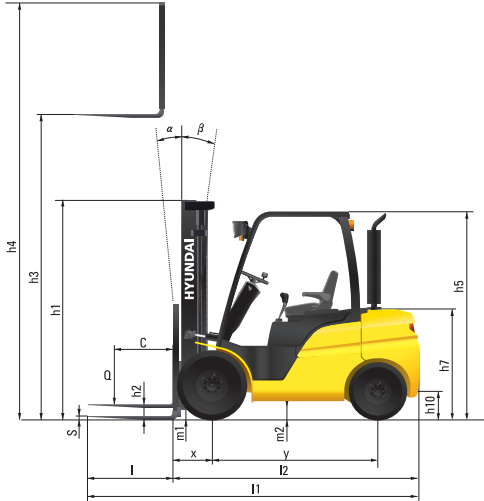

* The specifications in this brochure are subject to change for option.

Specifications

Identification					
1.1	Manufacturer	Hyundai			
1.2	Type	15D-9S	18D-9S	20D-9S	
1.3	Drive: Electric, Diesel, LPG Gas	DIESEL	DIESEL	DIESEL	
1.4	Type of operation: hand, pedestrian, standing, seated, order-picker	seated	seated	seated	
1.5	Load capacity (standard)	Q (kg)	1,500	1,800	2,000
1.6	Load center distance	c (mm)	500	500	500
1.8	Load distance, center of drive axle to forks	x (mm)	393	393	398
1.9	Wheelbase	y (mm)	1,410	1,410	1,410
Weights					
2.1	Service weight	kg	2,886	3,050	3,217
2.2	Axle loading, loaded front / rear	kg	3,803 / 583	4,169 / 630	4,540 / 677
2.3	Axle loading, unloaded front / rear	kg	1,353 / 1,533	1,311 / 1,738	1,266 / 1,951
Wheels, Chassis					
3.1	Tires : solid rubber (V), superelastic (SE), pneumatic (P), polyurethane (PE)		P	P	P
3.2	Tires size, front (Ø x width)		6.50-10-14PR	6.50-10-14PR	6.50-10-14PR
3.3	Tires size, rear (Ø x width)		5.00-8-8PR	5.00-8-8PR	5.00-8-8PR
3.5	Wheels, number front rear (x = driven wheels)		2 X / 2	2 X / 2	2 X / 2
3.6	Track width, front	b10 (mm)	890	890	890
3.7	Track width, rear	b11 (mm)	910	910	910
Basic Dimensions					
4.1	Mast / fork carriage tilt forward / backward	degrees	6 / 10	6 / 10	6 / 10
4.2	Lowered mast height (standard)	h1 (mm)	2,155	2,155	2,155
4.3	Free lift	h2 (mm)	35	35	40
4.4	Lift height (standard)	h3 (mm)	3,325	3,325	3,330
4.5	Extended mast height (standard)	h4 (mm)	4,320	4,320	4,320
4.7	Overhead load guard (cab) height	h5 (mm)	2,120	2,120	2,120
4.8	Seat height / standing height rel. to SIP	h7 (mm)	1,155	1,155	1,155
4.12	Coupling height	h10 (mm)	260	260	260
4.19	Overall length	l1 (mm)	3,124	3,154	3,189
4.20	Length to face of forks	l2 (mm)	2,224	2,254	2,289
4.21	Overall width	b1 (mm)	1,070	1,070	1,070
4.22	Fork dimensions (hook type) LxWxT	s / e / l (mm)	900 x 100 x 35	900 x 100 x 35	900 x 100 x 40
4.23	Fork carriage ISO 2328, class / type A,B		2A	2A	2A
4.24	Fork carriage width	b3 (mm)	1,006	1,006	1,006
4.31	Ground clearance, loaded, under mast	m1 (mm)	120	120	120
4.32	Ground clearance, centre of wheelbase	m2 (mm)	135	135	135
4.33	Aisle width for pallets 1000 x 1200 crossways (L x W)	Ast (mm)	3,599	3,624	3,664
4.34	Aisle width for pallets 800 x 1200 lengthways (W x L)	Ast (mm)	3,799	3,824	3,864
4.35	Turning radius	Wa (mm)	2,005	2,030	2,065
Performance Data					
5.1	Travel speed, loaded / unloaded (1/2)	km/h	19.4	19.4	19.4
5.2	Lift speed, loaded / unloaded	mm/s	620 / 650	620 / 650	620 / 650
5.3	Lowering speed, loaded / unloaded	mm/s	500 / 450	500 / 450	500 / 450
5.5	Drawbar pull, loaded	kg	1,476	1,478	1,483
5.7	Gradient performance, loaded	%	32.9	29.5	27.4
5.10	Service brake		FOOT / WET	FOOT / WET	FOOT / WET
Engine					
6.1	Engine manufacturer / type		Kubota V2203	Kubota V2203	Kubota V2203
6.2	Engine power acc. To ISO 1585	kW/rpm	30.8 / 2,400	30.8 / 2,400	30.8 / 2,400
6.3	Maximum Torque	kgf.m/rpm	14.3 / 1,600	14.3 / 1,600	14.3 / 1,600
6.4	No. of cylinder / cubic capacity	EA/cc	4 / 2,197	4 / 2,197	4 / 2,197
6.5	Fuel consumption acc. to VDI cycle	ℓ/h	N/A	N/A	2.6
Other Details					
8.2	Operating pressure (system/attachments)	bar	186 / 147	186 / 147	186 / 147

Load Capacity

15D-9S

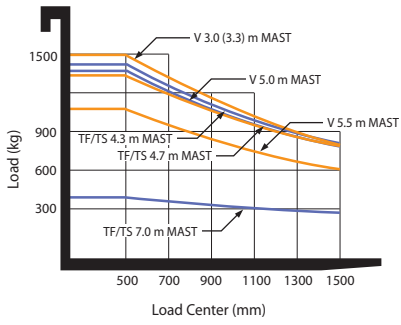

18D-9S

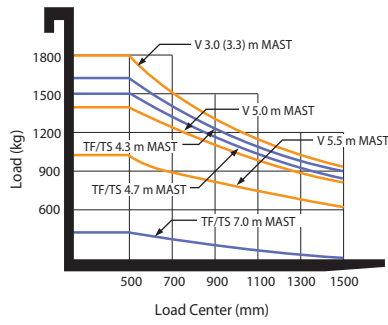

20D-9S

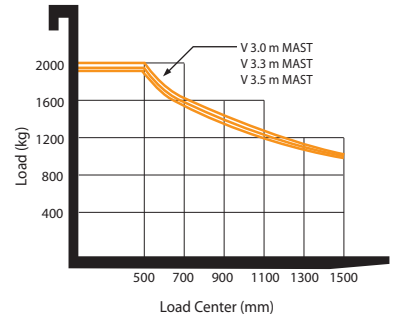
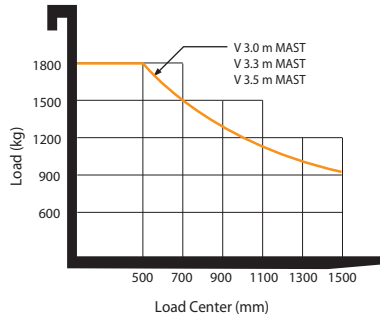
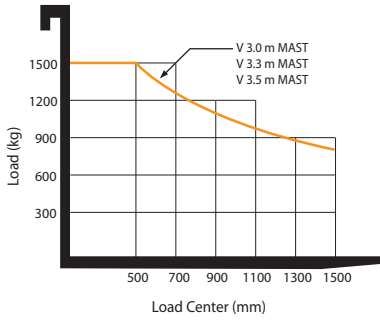
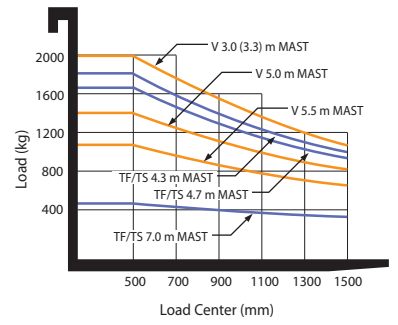

Various Attachments

Side Shift

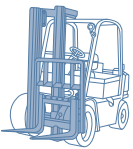

Hinged Fork



Hinged Bucket

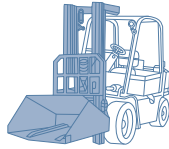

Rotating Fork

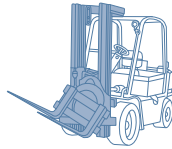

Push Pull



Rotating Roll Clamp

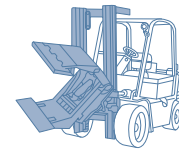

Load Stabilizer

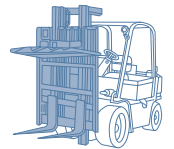

Carton Clamp

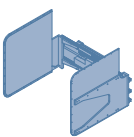

Pallet Invert

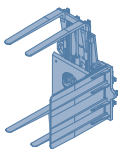

Drum Clamp

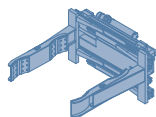

Bale Clamp

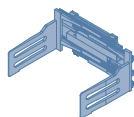

Load Extender

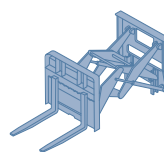

Fork Positioner

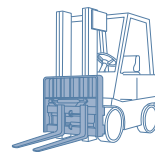

- * Standard and optional equipment may vary per country. Contact your Hyundai dealer for more information.
- * The photos may include attachments and optional equipment that are not available in your area.
- * Materials and specifications are subject to change without advance notice.
- * All imperial measurements rounded off to the nearest pound or inch.

PLEASE CONTACT

